









SYSTEM DOCUMENT FOR AACA2EDEMO – APP AREA ATBXLVL1

TABLE OF CONTENTS

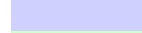
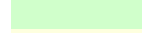





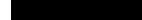

LEGENDS.....	2
Selected Options.....	4
Object List for AACA2EDEMO.....	4
Structure Chart Diagram (Expanded) for ATB6DFP.....	5
Data Flow Diagram (Normal) for ATB6DFP.....	7
Annotation for ATB6DFP	7
Data Flow Diagram (Normal) for ASDQREP	8
Data Model Diagram (Detailed) for ASDQREP.....	11
File Field Details for ASDQREP.....	15
Access path details for ASDQREP	16
Screen Design for ATB6DFP	17
Screen Design for ATB6DFP# (AZATB6DFPS1).....	17
Field List for Format ATB6DFP (AZATB6DFPS1).....	17
Data Content Diagram for AZATB6DFPS1.....	17
Screen Action Diagram for AZATB6DFPS1	18
Business Rules for ATB6DFP.....	19
Index.....	20

LEGENDS

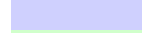
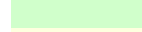

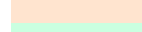
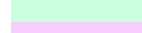
Structure Chart Diagram Legends

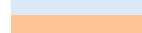
	Update
	Display
	Print
	Input
	Output
	Command
	Others
	Internal Routine
	Indeterminate
	Trigger







Data Flow Diagram Legends

	Main
	Update
	Display
	Print
	Input
	Output
	Called Program
	Calling Program
	Access Path
	Command
	Internal Routine
	Indeterminate
	Trigger
	Service Program
	Module
	Hibernate XML



Data Model Diagram Legends

	Refer To
	Owned By
	Uni-Directional
	Multiple Rels
	Internal
	External





Source/Business Rules Legends

	Comment
	Call Operation
	File Operation
	Program Structure Operation
	Field Operation
	Commented Out





Program Structure Chart Diagram Legends

	Programs/Modules
	Subroutines/Procedures

Data Content Diagram Legends

	Main File
	Validation File
	Field
	Field (Navigation Logic)

Screen Action Diagram Legends

-  Function (Same Program)
-  Function (Different Program)
-  Navigation Logic (Same Program)
-  Navigation Logic (Different Program)

SELECTED OPTIONS

1. Object List
2. Structure Chart - Expanded (Level 5)
3. Data Flow Diagram - Normal with Annotation
4. Data Model Diagram - Detailed
5. File Field Details
6. LF/Access Path details
7. Screen/Report Layout - Detailed
8. Business Rules – Detailed

OBJECT LIST FOR AACA2EDEMO

Name	Type	Attribute	Description
ATB6DFP	*PGM	RPG	W/W Prod for FundSrcMech Display file
ASDQREP	*FILE	PF	FUND SOURCE MECHANISM FSM Physical file

STRUCTURE CHART DIAGRAM (EXPANDED) FOR ATB6DFP

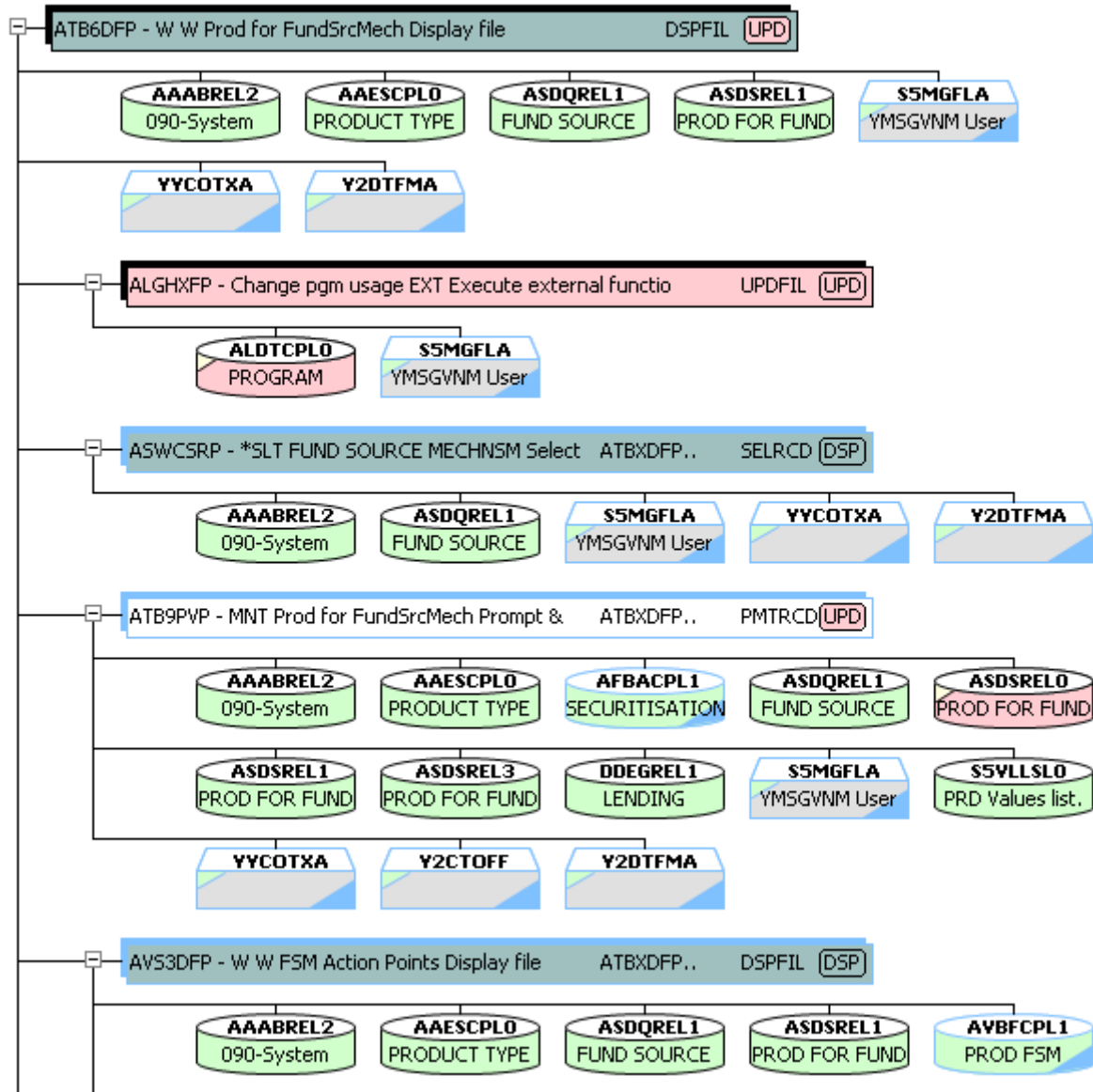

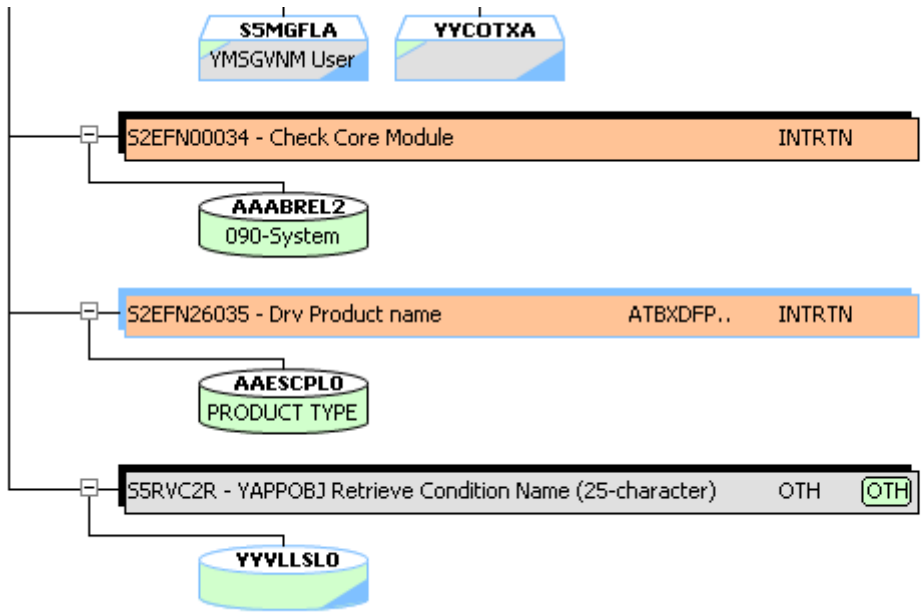

DATA FLOW DIAGRAM (NORMAL) FOR ATB6DFP

Annotation for ATB6DFP

These are comments and annotations made by users and stored in the repository during the course of their system analysis

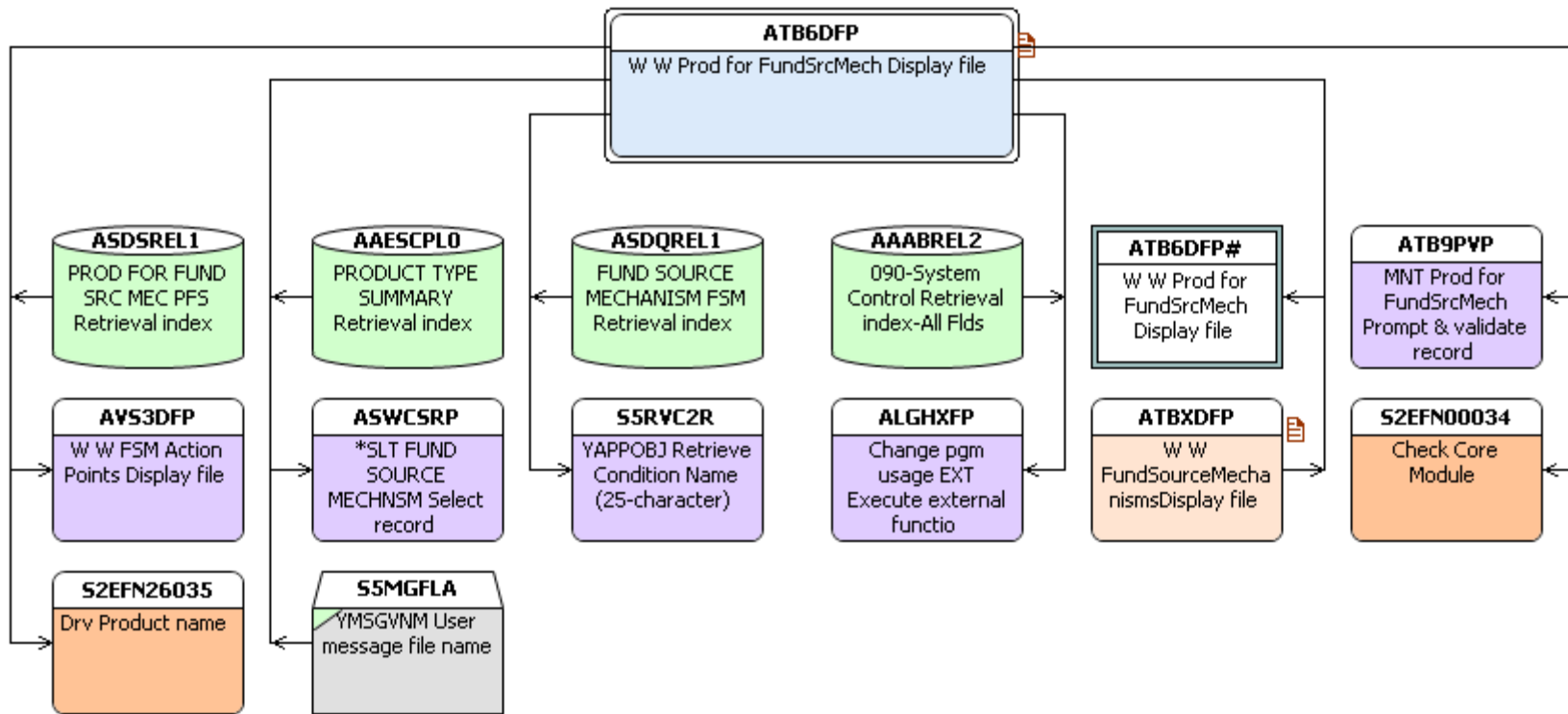

DATA FLOW DIAGRAM (NORMAL) FOR ASDQREP

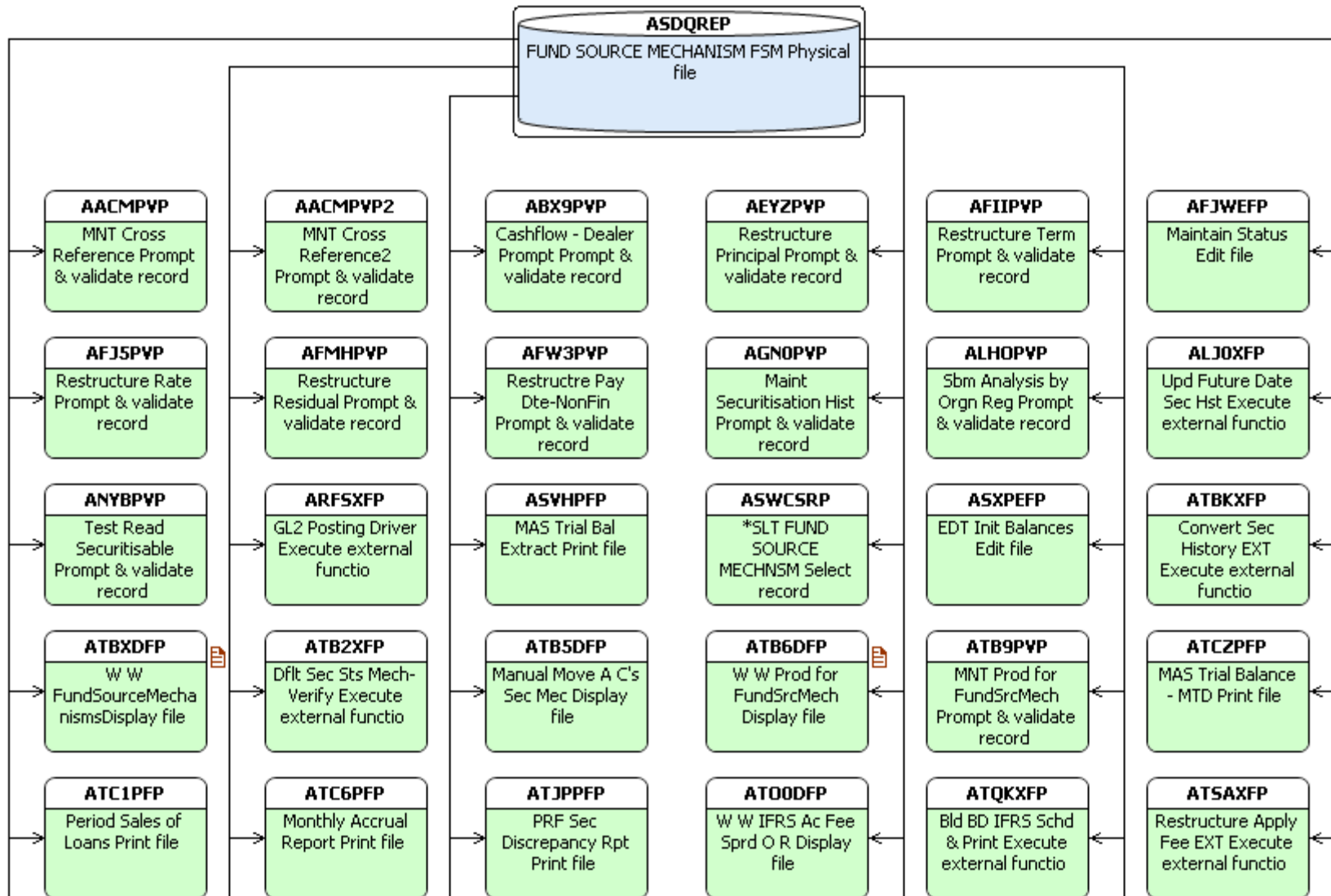

SYSTEM DOCUMENT FOR AACAZEDMO – APP AREA ATBXLVL1 – SAMPLE DOCS

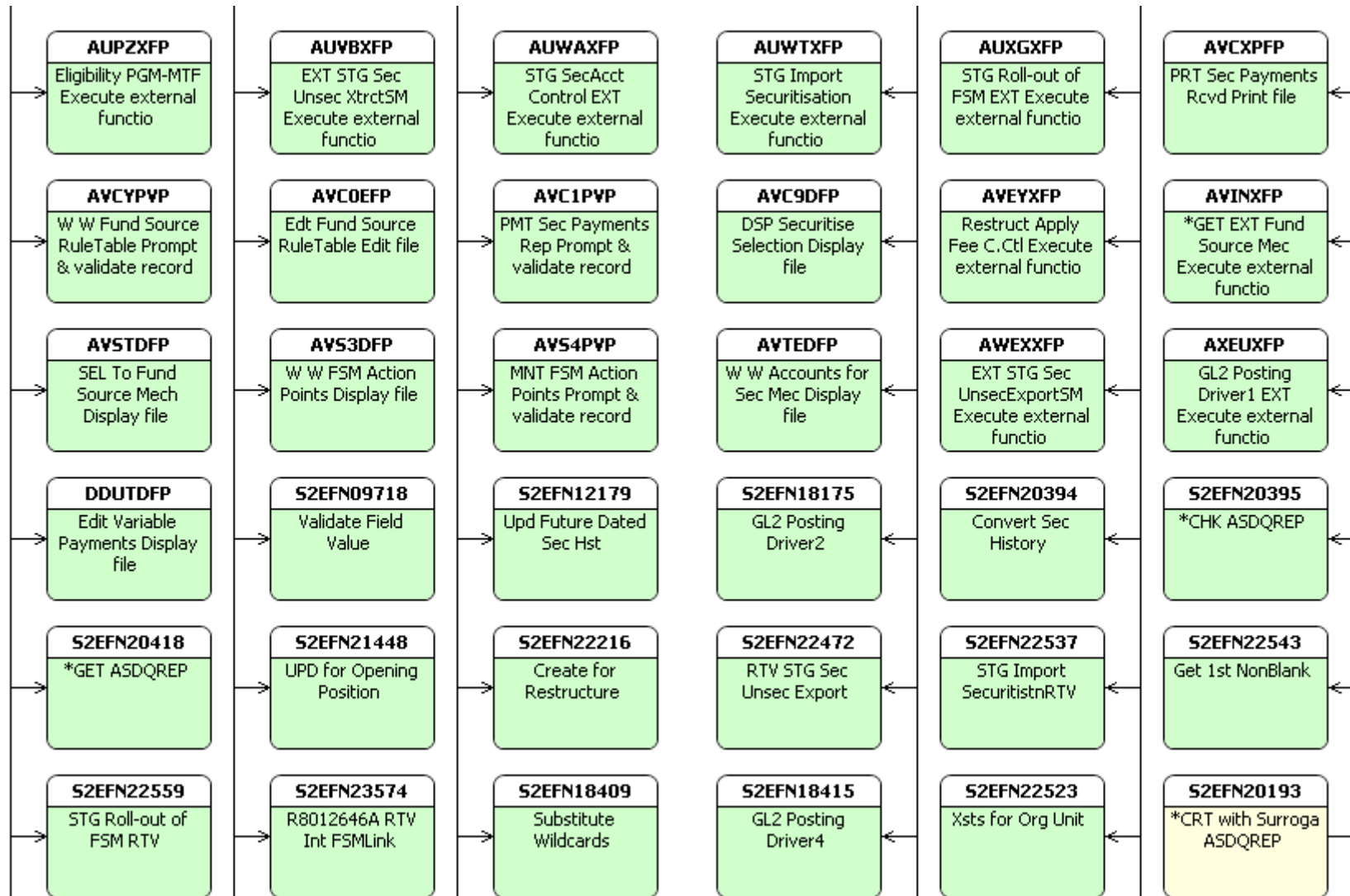

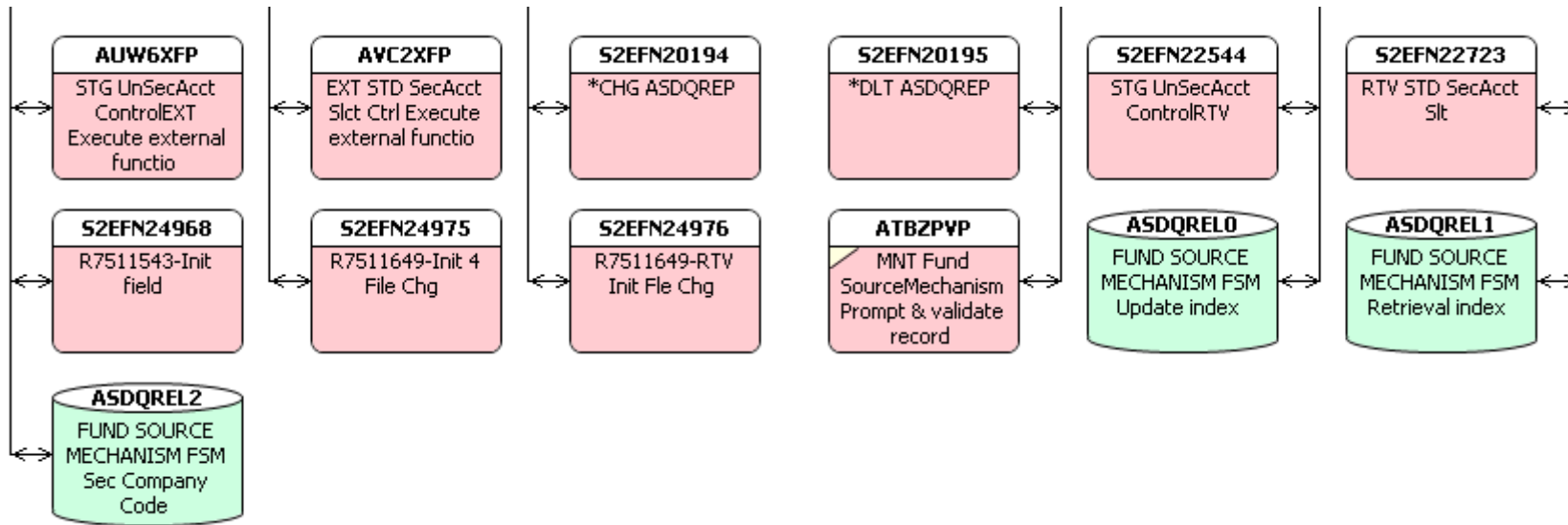

DATA MODEL DIAGRAM (DETAILED) FOR ASDQREP

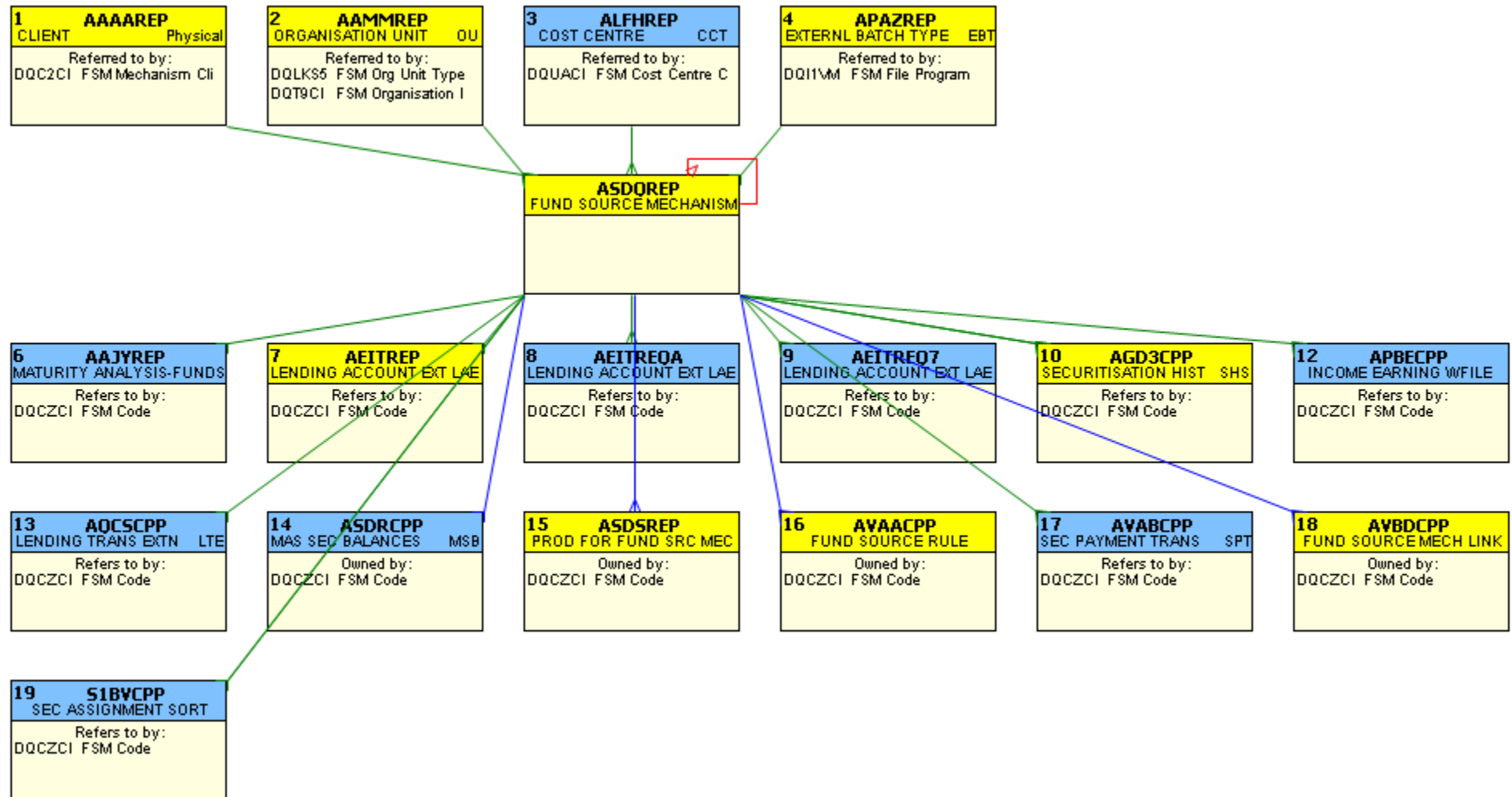

File Connection Details

Rel No.	Dependent File	Relation Type	Parent File	Dependent Fields	Parent Fields	Dep LF
1	FUND SOURCE MECHANISM FSM Physical file	REFERS TO	CLIENT Physical file	FSM Mechanism Client	001 Client Number	
2	FUND SOURCE MECHANISM FSM Physical file	REFERS TO	ORGANISATI ON UNIT OU Physical file	FSM Org Unit Type ID, FSM Organisation Init ID	Organisation Unit Type id, Organisation Unit id	
3	FUND SOURCE MECHANISM FSM Physical file	REFERS TO	COST CENTRE CCT Physical file	FSM Cost Centre Code	CCT Cost Centre Code	
4	FUND SOURCE MECHANISM FSM Physical file	REFERS TO	EXTERNL BATCH TYPE EBT Physical file	FSM File Program	EBT Code	
5	FUND SOURCE MECHANISM FSM Physical file	ACCESSES	FUND SOURCE MECHANISM FSM Physical file	FSM Transfer To FSM	FSM Code	ASDQRELO
6	MATURITY ANALYSIS-FUNDS Physical file	REFERS TO	FUND SOURCE MECHANISM FSM Physical file	Maturity Prf Fund Source	FSM Code	
7	LENDING ACCOUNT EXT LAE Physical file	REFERS TO	FUND SOURCE MECHANISM FSM Physical file	LAE Spare Code (6) 1 *NAR	FSM Code	
8	LENDING ACCOUNT EXT LAE By Franchise Code	REFERS TO	FUND SOURCE MECHANISM FSM Physical file	LAE Cost Centre	FSM Code	
9	LENDING ACCOUNT EXT LAE By	REFERS TO	FUND SOURCE MECHANISM	LAE Cost Centre	FSM Code	

SYSTEM DOCUMENT FOR AACAZEDEMO – APP AREA ATBXLVL1 – SAMPLE DOCS

Rel No.	Dependent File	Relation Type	Parent File	Dependent Fields	Parent Fields	Dep LF
	Originator		FSM Physical file			
10	SECURITISATION HIST SHS Physical file	REFERS TO	FUND SOURCE MECHANISM FSM Physical file	SHS Record Created Date	FSM Code	
11	SECURITISATION HIST SHS Physical file	REFERS TO	FUND SOURCE MECHANISM FSM Physical file	SHS New Fund Source Mech	FSM Code	
12	INCOME EARNING WFILE IEW Physical file	REFERS TO	FUND SOURCE MECHANISM FSM Physical file	IEW FSM Code	FSM Code	
13	LENDING TRANS EXTN LTE Physical file	REFERS TO	FUND SOURCE MECHANISM FSM Physical file	LTE Spare Code 10 - 2	FSM Code	
14	MAS SEC BALANCES MSB Physical file	OWNED BY	FUND SOURCE MECHANISM FSM Physical file	MSB Sec Mechanism Code	FSM Code	ASDRCPLO
15	PROD FOR FUND SRC MEC PFS Physical file	OWNED BY	FUND SOURCE MECHANISM FSM Physical file	FSM Code	FSM Code	ASDSRELO
16	FUND SOURCE RULE TABLEFSR Physical file	OWNED BY	FUND SOURCE MECHANISM FSM Physical file	FSM Code	FSM Code	AVAACPLO
17	SEC PAYMENT TRANS SPT Physical file	REFERS TO	FUND SOURCE MECHANISM FSM Physical file	SPT Fund Source	FSM Code	

SYSTEM DOCUMENT FOR AACAZEDEMO – APP AREA ATBXLVL1 – SAMPLE DOCS

Rel No.	Dependent File	Relation Type	Parent File	Dependent Fields	Parent Fields	Dep LF
18	FUND SOURCE MECH LINK FSL Physical file	OWNED BY	FUND SOURCE MECHANISM FSM Physical file	FSM Code	FSM Code	AVBDCPL0
19	SEC ASSIGNMENT SORT WORKF Physical file	REFERS TO	FUND SOURCE MECHANISM FSM Physical file	SAW Transfer To FSM	FSM Code	
20	SEC ASSIGNMENT SORT WORKF Physical file	REFERS TO	FUND SOURCE MECHANISM FSM Physical file	SAW Transfer From FSM	FSM Code	

FILE FIELD DETAILS FOR ASDQREP

Mnemonic	Long Name	Type	Length	Dec.Pos.	Inp.Buf. Pos.
DQCZCI	FSM_Code	CHAR	00006		00001
DQTLR	FSM_Description	CHAR	00050		00007
DQCMDA	FSM_Effective_Date	PACKED	00007	00	00057
DQCNDA	FSM_Expiry_Date	PACKED	00007	00	00061
DQHYVM	FSM_Eligibility_Program	CHAR	00010		00065
DQC2CI	FSM_Mechanism_Client	CHAR	00010		00075
DQCODA	FSM_Next_MovementDateIn	PACKED	00007	00	00085
DQCIDA	FSM_Next_MovementDateOut	PACKED	00007	00	00089
DQGVDA	FSM_Spare_Date_1	PACKED	00007	00	00093
DQCJDA	FSM_Spare_Date_2	PACKED	00007	00	00097
DQCKDA	FSM_Spare_Date_3	PACKED	00007	00	00101
DQL9S4	FSM_Create_IFRS_Fee_Sched	CHAR	00001		00105
DQMCS5	FSM_Process_on_Verify	CHAR	00001		00106
DQMAS4	FSM_Manual_Change_Option	CHAR	00001		00107
DQOZS5	FSM_Spare_Flag_1	CHAR	00001		00108
DQO0S5	FSM_Spare_Flag_2	CHAR	00001		00109
DQMBS4	FSM_Spare_Flag_3	CHAR	00001		00110
DQMBS5	FSM_Spare_Flag_4	CHAR	00001		00111
DQC0CI	FSM_Spare_Code_10_1	CHAR	00010		00112
DQC1CI	FSM_Spare_Code_10_2	CHAR	00010		00122
DQY2CT	FSM_Spare_Pct_1	PACKED	00007	04	00132
DQY3CT	FSM_Spare_Pct_2	PACKED	00007	04	00136
DQLKS5	FSM_Org_Unit_Type_ID	CHAR	00001		00140
DQT9CI	FSM_Organisation_Init_ID	CHAR	00004		00141
DQUACI	FSM_Cost_Centre_Code	CHAR	00006		00145
DQGLDA	FSM_Next_Selection_Date	PACKED	00007	00	00151
DQHPNE	FSM_Next_Selection_Freq1	PACKED	00005	00	00155
DQLFS5	FSM_Next_Selection_Freq2	CHAR	00001		00158
DQLGS5	FSM_Next_Selection_Freq3	CHAR	00002		00159
DQWDCI	FSM_Transfer_To_FSM	CHAR	00006		00161
DQGPDA	FSM_Next_Freq_Date_Spare	PACKED	00007	00	00167
DQHQNE	FSM_Freq_Part_1_Spare	PACKED	00005	00	00171
DQLHS5	FSM_Freq_Part_2_Spare	CHAR	00001		00174
DQLIS5	FSM_Freq_Part_3_Spare	CHAR	00002		00175
DQMAS5	FSM_Sovereign_Record	CHAR	00001		00177
DQT8CI	FSM_Surrogate	CHAR	00010		00178
DQO1S5	FSM_Print_Report	CHAR	00001		00188
DQI0VM	FSM_Report_Program	CHAR	00010		00189
DQO2S5	FSM_Generate_Ext_Batch	CHAR	00001		00199
DQI1VM	FSM_External_Batch_Code	CHAR	00010		00200
DQI2VM	FSM_Selection_Program	CHAR	00010		00210

ACCESS PATH DETAILS FOR ASDQREP

Access Path	Text	Unique Keys	Select/Omit	Field Names
ASDQREP	FUND SOURCE MECHANISM FSM Physical file	N	N	
ASDQREL0	FUND SOURCE MECHANISM FSM Update index	Y	N	DQCZCI
ASDQREL1	FUND SOURCE MECHANISM FSM Retrieval index	Y	N	DQCZCI
ASDQREL2	FUND SOURCE MECHANISM FSM Sec Company Code	N	N	DQLKS5,DQT9CI

Screen Action Diagram for AZATB6DFPS1

<input type="checkbox"/>	W/W Products for Funding Source - AZATB6DFPS1 ()
<input type="checkbox"/>	ATB9PVP - Add
<input type="checkbox"/>	FSM_Code -
<input type="checkbox"/>	X032_Product_Type -
<input type="checkbox"/>	*ACTIONTEXT - WorkField
<input type="checkbox"/>	AVS3DFP - Action Point
<input type="checkbox"/>	FSM_Code -
<input type="checkbox"/>	X032_Product_Type -
<input type="checkbox"/>	FSM_Description -
<input type="checkbox"/>	ATB9PVP - Change
<input type="checkbox"/>	FSM_Code -
<input type="checkbox"/>	X032_Product_Type -
<input type="checkbox"/>	*ACTIONTEXT - WorkField
<input type="checkbox"/>	ATB9PVP - Delete
<input type="checkbox"/>	FSM_Code -
<input type="checkbox"/>	X032_Product_Type -
<input type="checkbox"/>	*ACTIONTEXT - WorkField

BUSINESS RULES FOR ATB6DFP

Rule No.	Annotation	Rule	Rule Details	Field
00001	These are annotations made by analysts and developers against a specific business rule	IF CTL.*CMD key is *Add	<pre> If CTL.*CMD_key = '09' // Call program MNT Prod for FundSrcMech. Call MNT Prod for FundSrcMech Parm X032_Product_Type Parm FSM_Code Parm *BLANK // PGM.*Reload subfile = CND.*YES PGM.*Reload_subfile = 'Y' Endif </pre>	
00002		IF RCD.*SFLSEL is Change or delete	<pre> If RCD.*SFLSEL = '2'/'4' // Call program MNT Prod for FundSrcMech. Call MNT Prod for FundSrcMech Parm X032_Product_Type Parm FSM_Code Parm *BLANK // PGM.*Reload subfile = CND.*YES PGM.*Reload_subfile = 'Y' Endif </pre>	
00003	this is for actions and must be retained in the new program this note is for Stuart	IF RCD.*SFLSEL is Action=A	<pre> If RCD.*SFLSEL = 'A' // Call program W/W FSM Action Points. Call W/W FSM Action Points Parm FSM_Code Parm X032_Product_Type Parm FSM_Description // PGM.*Reload subfile = CND.*YES PGM.*Reload_subfile = 'Y' Endif </pre>	

INDEX

A

AAAAREP, *FILE, CLIENT Physical file 12

AAABREL2, *FILE, 090-System Control Retrieval index-All Flds..... 6, 7, 8

AACMPVP, *PGM, MNT Cross Reference Prompt & validate record.....9

AACMPVP2, *PGM, MNT Cross Reference2 Prompt & validate record9

AAESCPL0, *FILE, PRODUCT TYPE SUMMARY Retrieval index..... 6, 7, 8

AAJYREP, *FILE, MATURITY ANALYSIS-FUNDS Physical file 12

AAMMREP, *FILE, ORGANISATION UNIT OU Physical file..... 12

ABX9PVP, *PGM, Cashflow - Dealer Prompt Prompt & validate record9

AEITREP, *FILE, LENDING ACCOUNT EXT LAE Physical file 12

AEITREQ7, *FILE, LENDING ACCOUNT EXT LAE By Originator..... 12

AEITREQA, *FILE, LENDING ACCOUNT EXT LAE By Franchise Code..... 12

AEYZPVP, *PGM, Restructure Principal Prompt & validate record9

AFBACPL1, *FILE, SECURITISATION STATUS SCS Retrieval index6

AFIIPVP, *PGM, Restructure Term Prompt & validate record9

AFJ5PVP, *PGM, Restructure Rate Prompt & validate record9

AFJWEFP, *PGM, Maintain Status Edit file.....9

AFMHPVP, *PGM, Restructure Residual Prompt & validate record9

AFW3PVP, *PGM, Restructre Pay Dte-NonFin Prompt & validate record9

AGD3CPP, *FILE, SECURITISATION HIST SHS Physical file..... 12

AGN0PVP, *PGM, Maint Securitisation Hist Prompt & validate record.....9

ALDTCPL0, *FILE, PROGRAM USAGE PU Update index.....6

ALFHREP, *FILE, COST CENTRE CCT Physical file 12

ALGHXFP, *PGM, Change pgm usage EXT Execute external functio..... 6, 8

ALHOPVP, *PGM, Sbm Analysis by Orgn Reg Prompt & validate record.....9

ALJ0XFP, *PGM, Upd Future Date Sec Hst Execute external functio9

ANYBPVP, *PGM, Test Read Securitisable Prompt & validate record9

APAZREP, *FILE, EXTERNL BATCH TYPE EBT Physical file 12

APBECPP, *FILE, INCOME EARNING WFILE IEW Physical file..... 12

AQCSCPP, *FILE, LENDING TRANS EXTN LTE Physical file 12

ARFSXFP, *PGM, GL2 Posting Driver Execute external functio.....9

ASDQREL0, *FILE, FUND SOURCE MECHANISM FSM Update index 11, 16

ASDQREL1, *FILE, FUND SOURCE MECHANISM FSM Retrieval index..... 6, 8, 11, 16

ASDQREL2, *FILE, FUND SOURCE MECHANISM FSM Sec Company Code 11, 16

ASDQREP, *FILE, FUND SOURCE MECHANISM FSM Physical file 5, 9, 12, 15, 16

ASDRCPP, *FILE, MAS SEC BALANCES MSB Physical file 12

ASDSREL0, *FILE, PROD FOR FUND SRC MEC PFS Update index6

ASDSREL1, *FILE, PROD FOR FUND SRC MEC PFS Retrieval index..... 6, 8

ASDSREL3, *FILE, PROD FOR FUND SRC MEC PFS By Prod Default for Pro.....6

ASDSREP, *FILE, PROD FOR FUND SRC MEC PFS Physical file..... 12

ASVHPFP, *PGM, MAS Trial Bal Extract Print file9

ASWCSR, *PGM, *SLT FUND SOURCE MECHNSM Select record 6, 8, 9

ASXPEFP, *PGM, EDT Init Balances Edit file9

ATB2XFP, *PGM, Dflt Sec Sts Mech-Verify Execute external functio9

ATB5DFP, *PGM, Manual Move A C's Sec Mec Display file 9

ATB6DFP#, *FILE, W W Prod for FundSrcMech Display file8

ATB6DFP, *PGM, W W Prod for FundSrcMech Display file 6, 8, 9

ATB6DFP, *PGM, W/W Prod for FundSrcMech Display file..... 5, 17, 21

ATB9PVP, *PGM, MNT Prod for FundSrcMech Prompt & validate record..... 6, 8, 9

ATBKXFP, *PGM, Convert Sec History EXT Execute external functio9

ATBXDFP, *PGM, W W FundSourceMechanisms Display file 8, 9

ATBZPVP, *PGM, MNT Fund SourceMechanism Prompt & validate record 11

ATC1PFP, *PGM, Period Sales of Loans Print file9

ATC6PFP, *PGM, Monthly Accrual Report Print file9

ATCZPFP, *PGM, MAS Trial Balance - MTD Print file9

ATJPPFP, *PGM, PRF Sec Discrepancy Rpt Print file9

ATO0DFP, *PGM, W W IFRS Ac Fee Sprd O R Display file9

ATQKXFP, *PGM, Bld BD IFRS Schd & Print Execute external functio.....9

ATSAXFP, *PGM, Restructure Apply Fee EXT Execute external functio9

AUPZXFP, *PGM, Eligibility PGM-MTF Execute external functio 10

AUVBXFP, *PGM, EXT STG Sec Unsec XtrctSM Execute external functio..... 10

AUW6XFP, *PGM, STG UnSecAcct ControlEXT Execute external functio 11

AUWAXFP, *PGM, STG SecAcct Control EXT Execute external functio 10

SYSTEM DOCUMENT FOR AACA2EDEMO – APP AREA ATBXLVL1 – SAMPLE DOCS

AUWTFXP, *PGM, STG Import Securitisation Execute external functio 10
AUXGXF, *PGM, STG Roll-out of FSM EXT Execute external functio 10
AVAACPP, *FILE, FUND SOURCE RULE TABLEFSR Physical file 12
AVABCPP, *FILE, SEC PAYMENT TRANS SPT Physical file..... 12
AVBDCPP, *FILE, FUND SOURCE MECH LINK FSL Physical file..... 12
AVBFCPL1, *FILE, PROD FSM ACTION POINT PFA Retrieval index.....6
AVC0EFP, *PGM, Edt Fund Source RuleTable Edit file 10
AVC1PVP, *PGM, PMT Sec Payments Rep Prompt & validate record 10
AVC2XFP, *PGM, EXT STD SecAcct Slct Ctrl Execute external functio 11
AVC9DFP, *PGM, DSP Securitise Selection Display file..... 10
AVCXFP, *PGM, PRT Sec Payments Rcvd Print file 10
AVCYPVP, *PGM, W W Fund Source RuleTable Prompt & validate record..... 10
AVEYXFP, *PGM, Restruct Apply Fee C.Ctl Execute external functio 10
AVINXFP, *PGM, *GET EXT Fund Source Mec Execute external functio 10
AVS3DFP, *PGM, W W FSM Action Points Display file 6, 8, 10
AVS4PVP, *PGM, MNT FSM Action Points Prompt & validate record 10
AVSTDFP, *PGM, SEL To Fund Source Mech Display file..... 10
AVTEDFP, *PGM, W W Accounts for Sec Mec Display file 10
AWEXXFP, *PGM, EXT STG Sec UnsecExportSM Execute external functio..... 10
AXEUXFP, *PGM, GL2 Posting Driver1 EXT Execute external functio..... 10
AZATB6DFPS1..... 19, 20
D
DDEGREL1, *FILE, LENDING PRODUCT TYPE Retrieval index.....6
DDUTDFP, *PGM, Edit Variable Payments Display file..... 10
F
Field List for Format ATB6DFP (AZATB6DFPS1) 18
O
Object List.....5
S
S1BVCPP, *FILE, SEC ASSIGNMENT SORT WORKF Physical file 12
S2EFN00034, *INTRTN, Check Core Module 7, 8
S2EFN09718, *INTRTN, Validate Field Value..... 10
S2EFN12179, *INTRTN, Upd Future Dated Sec Hst 10
S2EFN18175, *INTRTN, GL2 Posting Driver2 10
S2EFN18409, *INTRTN, Substitute Wildcards 10
S2EFN18415, *INTRTN, GL2 Posting Driver4 10
S2EFN20193, *INTRTN, *CRT with Surroga ASDQREP..... 10
S2EFN20194, *INTRTN, *CHG ASDQREP 11
S2EFN20195, *INTRTN, *DLT ASDQREP 11
S2EFN20394, *INTRTN, Convert Sec History 10
S2EFN20395, *INTRTN, *CHK ASDQREP..... 10
S2EFN20418, *INTRTN, *GET ASDQREP..... 10
S2EFN21448, *INTRTN, UPD for Opening Position 10
S2EFN22216, *INTRTN, Create for Restructure 10
S2EFN22472, *INTRTN, RTV STG Sec Unsec Export..... 10
S2EFN22523, *INTRTN, Xsts for Org Unit 10
S2EFN22537, *INTRTN, STG Import SecuritistnRTV..... 10
S2EFN22543, *INTRTN, Get 1st NonBlank 10
S2EFN22544, *INTRTN, STG UnSecAcct ControlRTV 11
S2EFN22559, *INTRTN, STG Roll-out of FSM RTV..... 10
S2EFN22723, *INTRTN, RTV STD SecAcct Slct 11
S2EFN23574, *INTRTN, R8012646A RTV Int FSMLink 10
S2EFN24968, *INTRTN, R7511543-Init field..... 11
S2EFN24975, *INTRTN, R7511649-Init 4 File Chg 11
S2EFN24976, *INTRTN, R7511649-RTV Init Fle Chg 11
S2EFN26035, *INTRTN, Drv Product name..... 7, 8
S5MGFLA, *DTAARA, YMSGVNM User message file name..... 6, 7, 8
S5RVC2R, *PGM, YAPPOBJ Retrieve Condition Name (25-character)..... 7, 8
S5VLLSLO, *FILE, PRD Values list. Master index 6
Y
Y2CTOFF, *DTAARA,6
Y2DTFMA, *DTAARA,.....6
YYCOTXA, *DTAARA,..... 6, 7
YYVLLSLO, *FILE,.....7